

Photo Transistor  
Ligitek LPT2023  
Jameco Part: 112176

Photo LED  
Ligitek LIR2403  
Jameco Part: 112150  
Note: Replace VR1, VR2 with 1K Pots

NOTE: Change VR1 and VR2 to 1K Ohm for easier calibration

Hall Effect Switch  
Original  
UGN3120U  
Replacements  
Melexis Inc - US5881EUA  
Digi-Key Part No. US5881EUA-ND  
Allegro A3114-EUA

Comparator  
LM2901  
BA10339  
LM339

OUT1 & OUT2 Oscilloscope View

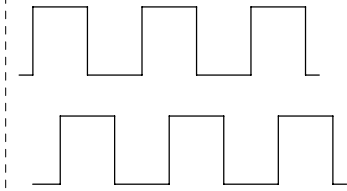

NOTE:  
Hall Effect on RA Motor Assembly Only

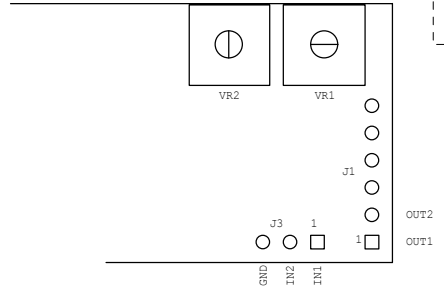
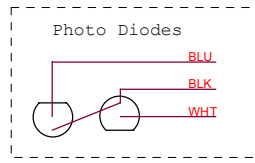
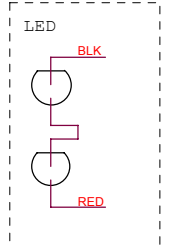
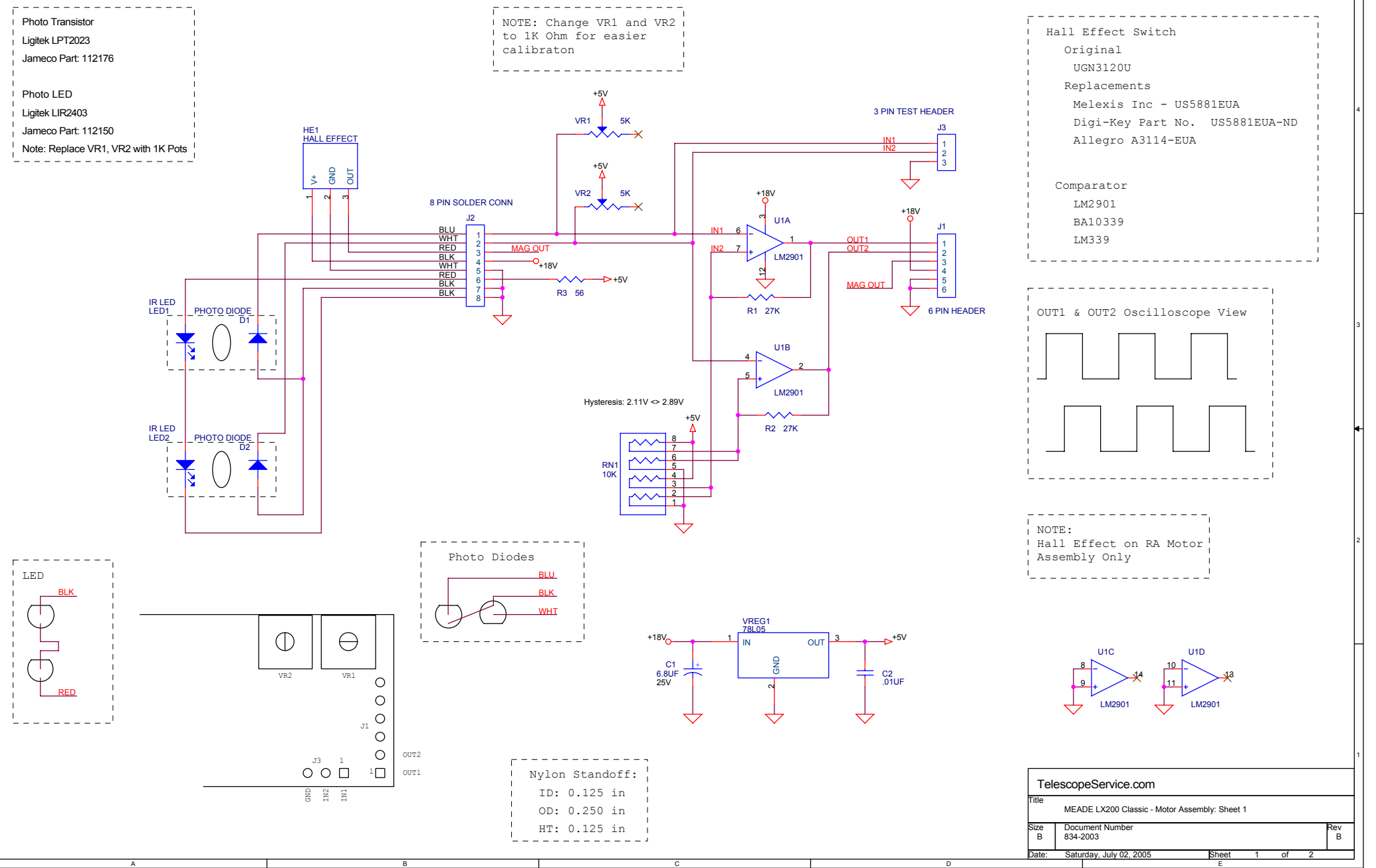

Nylon Standoff:  
ID: 0.125 in  
OD: 0.250 in  
HT: 0.125 in

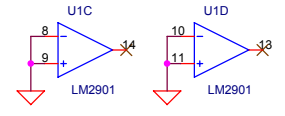
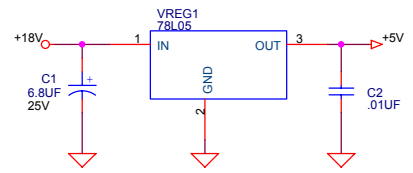

TelescopeService.com		
Title MEADE LX200 Classic - Motor Assembly: Sheet 1		
Size B	Document Number 834-2003	Rev B
Date: Saturday, July 02, 2005	Sheet 1	of 2